

# 1273ZJ-130-TRL

## Wall Mounting Bracket for Dome Camera (with adaptor plate)



### Features:

- Aluminum alloy material with surface spray treatment
- The outlet hole makes the feature looks better Better water proof design
- Convenient installation coordinating with lower bowl

### Parameter:

|                      |  |
|----------------------|--|
| Model                | 1273ZJ-130(-TRL)   |
| Parameters           | Wall Mounting Bracket for Dome Camera (with adaptor plate) |
| Appearance           | White  |
| Range of Application | Suitable for dome camera wall mounting                     |
| Material             | Aluminum Alloy   |
| Dimension            | Φ132×183.5×228.5mm   |
| Weight               | 870g   |

### Notice:

- The bracket should be installed on flat wall
- The wall must be capable of supporting over 3 times as much as the total weight of the camera and the mount.
- The maximum load capacity of the bracket is 4.5KG

### Model Suitable:

AC334-FD4  
AC334-FD4M  
AC335-FD4

# 1273ZJ-130-TRL

## Wall Mounting Bracket for Dome Camera (with adaptor plate)

### Dimension:

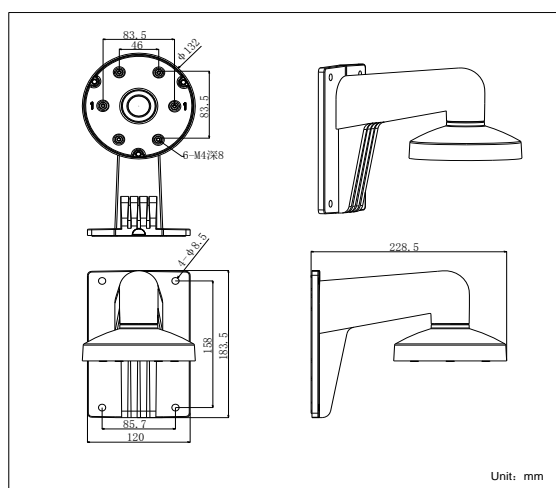

### Installation Step:

- ① Choose the appropriate wall to fix the bracket and wire

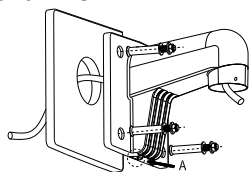

A: Cable entry hole

- ② Fix cap to bracket and complete wiring

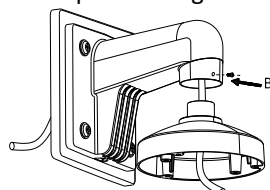

B: Fastening screw

- ③ Screw up and fix the cap

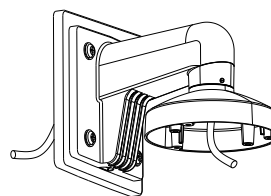

- ④ Take adaptor from the packaging of bracket

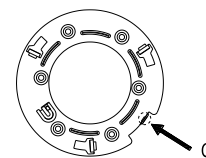

C: Bayonet of adaptor

- ⑤ Check the hole site and fix adaptor to cap

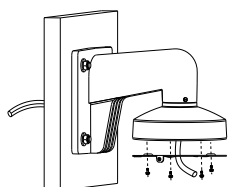

- ⑥ Connect the cable and fix dome camera to cap

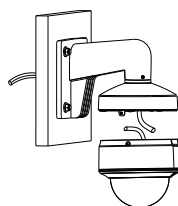

- ⑦ Rotate the dome camera moderately and screw up the fastening screw

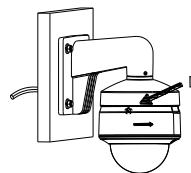

D: Fastening screw of dome camera

- ⑧ Installation complete

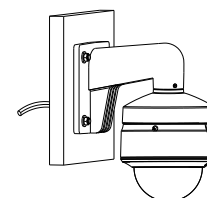

**Note: The actual bracket may vary from the picture above.**