

NC324-XD

4MP IR Fixed Turret Network Camera



Key Features

- 1/3" Progressive Scan CMOS
- 2560 × 1440@30fps
- 2.8/4/6/8 mm fixed lens
- Color: 0.01 Lux @ (F1.2, AGC ON), 0.018 Lux @ (F1.6, AGC ON), 0 Lux with IR
- H.265+, H.265, H.264+, H.264
- Three streams
- 120dB WDR
- 2 Behavior analyses, and face detection
- BLC/3D DNR/ROI
- IP67
- Built-in micro SD/SDHC/SDXC card slot, up to 128 GB
- 3-Axis adjustment



NC324-XD

4MP IR Fixed Turret Network Camera

Specifications

Camera	
Image Sensor	1/3" Progressive Scan CMOS
Min. Illumination	Color: 0.01 Lux @ (F1.2, AGC ON), 0.018 Lux @ (F1.6, AGC ON), 0 Lux with IR
Shutter Speed	1/3 s to 1/100,000 s
Slow Shutter	Yes
Auto-Iris	No
Day & Night	IR Cut Filter
Digital Noise Reduction	3D DNR
WDR	120dB
3-Axis Adjustment	Pan: 0° to 360°, tilt: 0° to 75°, rotate: 0° to 360°
Lens	
Focal length	2.8/4/6/8 mm
Aperture	F1.6
Focus	Manual
FOV	2.8 mm: horizontal FOV: 98°, vertical FOV: 55°, diagonal FOV: 114° 4 mm: horizontal FOV: 78°, vertical FOV: 42°, diagonal FOV: 93° 6 mm: horizontal FOV: 48°, vertical FOV: 27°, diagonal FOV: 54° 8 mm: horizontal FOV: 37°, vertical FOV: 21°, diagonal FOV: 44°
Lens Mount	M12
IR	
IR Range	Up to 30 m
Wavelength	850nm
Compression Standard	
Video Compression	Main stream: H.265/H.264 Sub-stream: H.265/H.264/MJPEG Third stream: H.265/H.264
H.264 Type	Main Profile/High Profile
H.264+	Main stream and sub-stream support
H.265 Type	Main Profile
H.265+	Main stream and sub-stream support
Video Bit Rate	32 Kbps to 16 Mbps
Smart Feature-set	
Behavior Analysis	Line crossing detection, intrusion detection
Face Detection	Yes
Region of Interest	1 fixed region for main stream and sub-stream
Image	
Max. Resolution	2560 × 1440
Main Stream	50Hz: 25fps (2560 × 1440, 2304 × 1296, 1920 × 1080) 60Hz: 30fps (2560 × 1440, 2304 × 1296, 1920 × 1080)
Sub-Stream	50Hz: 25fps (640 × 480, 640 × 360, 320 × 240) 60Hz: 30fps (640 × 480, 640 × 360, 320 × 240)
Third Stream	50Hz: 25fps (1280 × 720, 640 × 360, 352 × 288) 60Hz: 30fps (1280 × 720, 640 × 360, 352 × 240)
Image Enhancement	BLC/3D DNR



NC324-XD

4MP IR Fixed Turret Network Camera

Image Setting	Rotate mode, saturation, brightness, contrast, sharpness adjustable by client software or web browser
Target Cropping	No
Day/Night Switch	Auto/Schedule
Network	
Network Storage	Support Micro SD/SDHC/SDXC card (128G), local storage and NAS (NFS,SMB/CIFS), ANR
Alarm Trigger	Motion detection, video tampering, network disconnected, IP address conflict, illegal login, HDD full, HDD error
Protocols	TCP/IP, ICMP, HTTP, HTTPS, FTP, DHCP, DNS, DDNS, RTP, RTSP, RTCP, PPPoE, NTP, UPnP™, SMTP, SNMP, IGMP, 802.1X, QoS, IPv6, Bonjour
General Function	One-key reset, anti-flicker, three streams, heartbeat, mirror, password protection, privacy mask, watermark, IP address filter
API	ONVIF (PROFILE S, PROFILE G), ISAPI
Simultaneous Live View	Up to 6 channels
User/Host	Up to 32 users 3 levels: Administrator, Operator and User
Client	iVMS-4200, Hik-Connect, iVMS-5200
Web Browser	IE8+, Chrome 31.0-44, Firefox 30.0-51, Safari 8.0+
Interface	
Communication Interface	1 RJ45 10M/100M self-adaptive Ethernet port
On-board storage	Built-in Micro SD/SDHC/SDXC slot, up to 128 GB
SVC	H.264 and H.265 encoding
Reset Button	Yes
General	
Operating Conditions	-30 °C to +60 °C (-22 °F to +140 °F), Humidity 95% or less (non-condensing)
Power Supply	12 VDC ± 25%, Φ 5.5 mm coaxial power plug PoE (802.3af, class 3)
Power Consumption and Current	12 VDC, 0.5A, max. 6W PoE (802.3af, 37V to 57V), 0.2A to 0.1A, max. 7.5W
Protection Level	IP67 TVS 2000V Lightning Protection, Surge Protection and Voltage Transient Protection
Material	Metal
Dimensions	Camera: Φ 127.3 × 95.9 mm (Φ 5.0" × 3.8") Package: 150 × 150 × 141 mm (5.9" × 5.9" × 5.6")
Weight	Camera: Approx. 610 g (1.3 lb.) With Package: Approx. 880 g (1.9 lb.)

NC324-XD

4MP IR Fixed Turret Network Camera

Dimensions

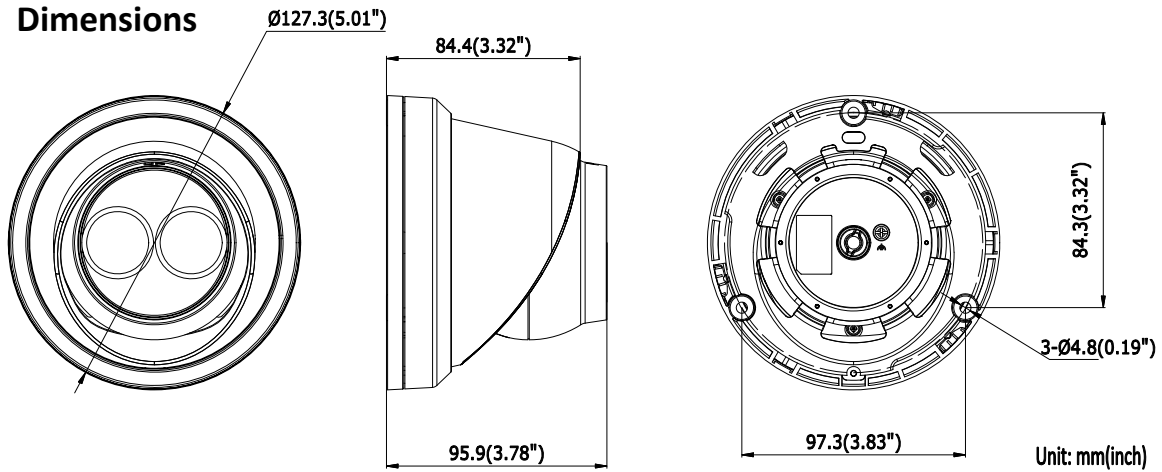

Accessories



1273ZJ-130-TRL
Wall Mount



1275ZJ
Vertical Pole Mount



1276ZJ
Corner Mount



1280ZJ-DM8
Junction Box



1281ZJ-M
Inclined Ceiling Mount