

NP214-IR/32X

4MP 32× Network IR Speed Dome



The NP214-IR/32X 4MP 32× Network IR Speed Dome adopts 1/2.5" progressive scan CMOS chip. With the 32× optical zoom lens, the camera offers more details over expansive areas.

This series of cameras can be widely used for wide ranges of high-definition, such as the rivers, roads, railways, airports, squares, parks, scenic spots, and venues, etc.

Key Features

- 1/2.5" progressive scan CMOS
- Up to 2560 × 1440@30fps resolution
- Min. illumination: Color: 0.005 Lux @(F1.6, AGC ON)
- B/W: 0.001 Lux @(F1.6, AGC ON) 0 Lux with IR
- 32× optical zoom, 16× digital zoom
- WDR, HLC, BLC, 3D DNR, Defog, EIS, Regional Exposure, Regional Focus
- Up to 150 m IR distance 24 VAC & Hi-PoE
- Support H.265+/H.265 video compression
- IP66
- ONVIF, ISAPI, and CGI
- Audio input/output
- Alarm input/output

NP214-IR/32X

4MP 32× Network IR Speed Dome

Camera Module	
Image Sensor	1/2.5" progressive scan CMOS
Min. Illumination	Color: 0.005 Lux @(F1.6, AGC ON) B/W: 0.001Lux @(F1.6, AGC ON) 0 Lux with IR
White Balance	Auto/Manual/ATW (Auto-tracking White Balance)/Indoor/Outdoor/Fluorescent Lamp/Sodium Lamp
Gain	Auto/Manual
Shutter Time	50Hz: 1/1 s to 1/30,000 s 60Hz: 1/1 s to 1/30,000 s
Day & Night	IR Cut Filter
Digital Zoom	16×
Privacy Mask	24 programmable privacy masks
Focus Mode	Auto/Semi-automatic/Manual
WDR	120 dB WDR (not supported by full frame rate)
Lens	
Focal Length	4.8 mm to 153 mm, 32× optical zoom
Zoom Speed	Approx. 5.6 s (optical lens, wide-tele)
Field of View	Horizontal field of view: 61.3° to 2.18° (Wide-Tele) Vertical field of view: 36.9° to 1.22° (Wide-Tele) Diagonal field of view: 68.4 to 2.5° (Wide-Tele)
Working Distance	10 mm to 1500 mm (wide-tele)
Aperture Range	F1.2 to F4.4
IR	
IR Distance	150 m
Smart IR	Support
PTZ	
Movement Range (Pan)	360° endless
Pan Speed	Configurable, from 0.1°/s to 120°/s Preset speed: 120°/s
Movement Range (Tilt)	From -15° to 90° (auto-flip)
Tilt Speed	Configurable, from 0.1°/s to 80°/s Preset Speed: 80°/s
Proportional Zoom	Support
Presets	300
Patrol Scan	8 patrols, up to 32 presets for each patrol
Pattern Scan	4 pattern scans, record time over 10 minutes for each scan
Power-off Memory	Support
Park Action	Preset/Pattern Scan/Patrol Scan/Auto Scan/Tilt Scan/Random Scan/Frame Scan/Panorama Scan
3D Positioning	Support
PTZ Position Display	Support
Preset Freezing	Support
Scheduled Task	Preset/Pattern Scan/Patrol Scan/Auto Scan/Tilt Scan/Random Scan/Frame Scan/Panorama Scan/Dome Reboot/Dome Adjust/Aux Output
Compression Standard	
Video Compression	Main Stream: H.265+/H.265/H.264+/H.264 Sub-stream: H.265/H.264/MJPEG Third Stream: H.265/H.264/MJPEG
H.264 Type	Baseline Profile/Main Profile/High Profile



NP214-IR/32X

4MP 32× Network IR Speed Dome

H.264+	Support
H.265 Type	Main Profile
H.265+	Support
Video Bitrate	256 Kbps to 16384 Kbps
SVC	Support
Audio Compression	G.711alaw/G.711ulaw/G.722.1/G.726/MP2L2/PCM
Audio Bitrate	G.711alaw/G.711ulaw: 64 Kbps G.722.1/G.726: 16 Kbps MP212/PCM: 32 Kbps to 160 Kbps
Smart Features	
Basic Event	Motion Detection, Video Tampering Detection, Exception
Smart Event	Intrusion Detection, Line Crossing Detection, Region Entrance Detection, Region Exiting Detection, Object Removal Detection, Unattended Baggage Detection, Audio Exception Detection
Smart Record	ANR (Automatic Network Replenishment), Dual-VCA
ROI	Main stream, sub-stream, and third stream respectively support four fixed areas.
Image	
Max. Resolution	2560 × 1440
Main Stream	50Hz: 25fps (2560 × 1440, 2048 × 1536, 1920 × 1080, 1280 × 960, 1280 × 720) 50fps (1920 × 1080, 1280 × 960, 1280 × 720) 60Hz: 30fps (2560 × 1440, 2048 × 1536, 1920 × 1080, 1280 × 960, 1280 × 720) 60fps (1920 × 1080, 1280 × 960, 1280 × 720)
Sub-Stream	50Hz: 25fps (704 × 576, 640 × 480, 352 × 288) 60Hz: 30fps (704 × 480, 640 × 480, 352 × 240)
Third Stream	50Hz: 25fps (2560 × 1440, 2048 × 1536, 1920 × 1080, 1280 × 960, 1280 × 720, 704 × 576, 640 × 480, 352 × 288) 60Hz: 30fps (2560 × 1440, 2048 × 1536, 1920 × 1080, 1280 × 960, 1280 × 720, 704 × 480, 640 × 480, 352 × 240)
Image Enhancement	HLC/BLC/3D DNR/Defog/EIS/Regional Exposure/Regional Focus
Network	
Network Storage	Built-in memory card slot, support Micro SD/SDHC/SDXC, up to 256 GB; NAS (NPS, SMB/CIFS), ANR
Alarm Linkage	Alarm actions, such as Preset, Patrol Scan, Pattern Scan, Trigger Recording, Trigger Alarm Output, Notify Surveillance Center, Upload to FTP/Memory Card/NAS, Send Email, etc.
Protocols	IPv4/IPv6, HTTP, HTTPS, 802.1x, Qos, FTP, SMTP, UPnP, SNMP, DNS, DDNS, NTP, RTSP, RTCP, RTP, TCP/IP, UDP, IGMP, ICMP, DHCP, PPPoE, Bonjour
API	Open-ended, support ONVIF, ISAPI, and CGI, support HIKVISION SDK and Third-Party Management Platform
Simultaneous Live View	Up to 20 channels
User/Host	Up to 32 users 3 levels: Administrator, Operator and User
Security Measures	User authentication (ID and PW), Host authentication (MAC address); HTTPS encryption; IEEE 802.1x port-based network access control; IP address filtering
Client	iVMS-4200, iVMS-4500, iVMS-5200, Hik-Connect
Web Browser	IE 8 to 11, Chrome 31.0 to 44, Firefox 30.0 to 51
Interface	
Network Interface	1 RJ45 10 M/100 M Ethernet, Hi-PoE
Audio	1-ch audio input, 2 to 2.4 V[p-p], 1 K Ω \pm 10% 1-ch audio output, line level, impedance: 600 Ω
Alarm	2-ch alarm input/1-ch alarm output
General	
Power	24 VAC and Hi-PoE Max.: 30 W (Max. 10 W for IR)
Working Temperature	-30°C to 65°C (-22°F to 149°F)
Working Humidity	\leq 90%

NP214-IR/32X

4MP 32× Network IR Speed Dome

Protection Level	IP66 Standard, TVS 4000V Lightning Protection, Surge Protection and Voltage Transient Protection
Material	ADC 12, PC+10% GF
Dimensions	Φ 208 mm × 345 mm (Φ 8.19" × 13.58")
Weight	Approx. 3.3 kg (7.28 lb)



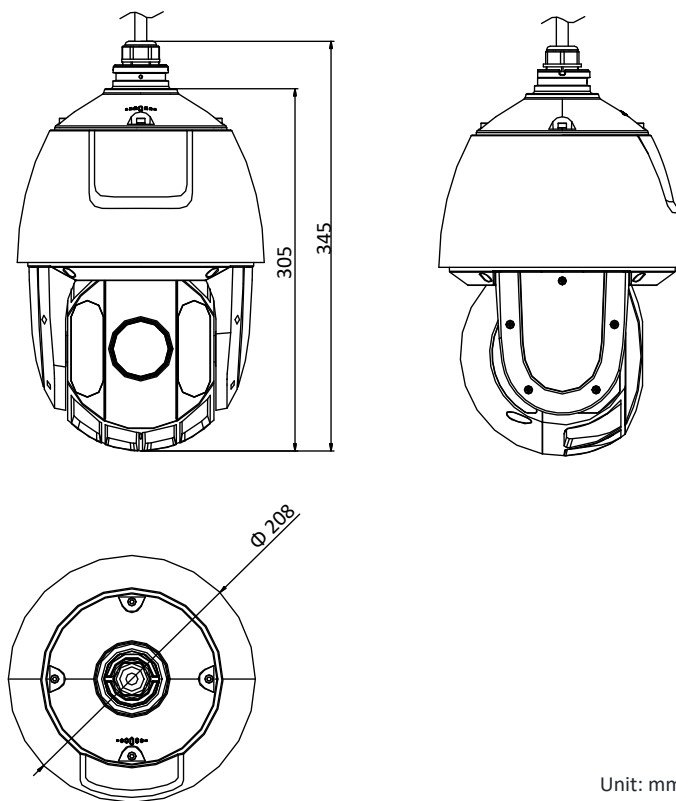





Dimensions



NP214-IR/32X

4MP 32× Network IR Speed Dome

Accessories

	1602ZJ	Wall Mounting Bracket
	1602ZJ-corner	Corner Mounting Bracket
	1602ZJ-pole	Vertical Pole Mounting Bracket
	1602ZJ-box	Wall Mounting Bracket with Junction Box
	1663ZJ	Ceiling Mounting Bracket
	1661ZJ	Pendant Mounting Bracket
	1662ZJ	Pendant Mounting Bracket
	1619ZJ	Gooseneck Mounting Bracket