

AC346-OD 2.8mm

5 MP Ultra-Low Light Camera



Key Feature

- 5 MP high performance CMOS
- 2560 × 1944 resolution
- 2.8 mm fixed lens
- EXIR 2.0, smart IR, up to 30 m IR distance
- OSD menu, 3D DNR, 130 dB true WDR
- 4 in 1 video output (switchable TVI/AHD/CVI/CVBS)
- IP67, IK10
- Up the coax (UTC-C)



AC346-OD 2.8mm

5 MP Ultra-Low Light Camera

Camera	
Image Sensor	5 megapixel progressive scan CMOS
Signal System	PAL/NTSC
Resolution	2560 (H) × 1944 (V)
Min. Illumination	Color: 0.003 Lux@(F1.2, AGC ON), 0 Lux with IR
Frame Rate	TVI: 2 MP@25fps, 2 MP@30fps, 4 MP@25fps, 4 MP@30fps, 5 MP@20fps AHD: 4 MP@25fps, 4 MP@30fps, 5 MP@20fps CVI: 4 MP@25fps, 4 MP@30fps CVBS: PAL, NTSC
Shutter Time	PAL: 1/25 s to 1/50,000 s NTSC: 1/30 s to 1/50,000 s
Lens	2.8 mm fixed lens
Horizontal Field of View	98° (2.8 mm),
Lens Mount	M12
Day & Night	IR cut filter
Angle Adjustment (Bracket)	Pan: 0° to 355°, Tilt: 0° to 75°, Rotate: 0° to 355°
Synchronization	Internal synchronization
WDR (Wide Dynamic Range)	≥ 130 dB
Menu	
AGC	Yes
Day/Night Mode	Auto/Color/BW (Black and White)
White Balance	Auto/Manual
BLC (Backlight Compensation)	Yes
WDR	Yes
3D DNR	Level 1 to 9
Privacy Mask	4 programmable privacy masks
Motion Detection	4 programmable areas
Language	English
Functions	Brightness, Sharpness, 3D DNR, Mirror, Smart IR
Interface	
Video Output	1 HD analog output
Switch Button	TVI/AHD/CVI/CVBS
General	
Operating Conditions	-40 °C to 60 °C (-40 °F to 140 °F), humidity: 90% or less (non-condensing)
Power Supply	12 VDC ± 25% <i>*You are recommended to use one power adapter to supply the power for one camera.</i>
Power Consumption	Max. 5.8 W
Protection Level	IP67, IK10
Material	Metal
IR Range	Up to 30 m
Communication	Up the coax, Protocol: UTC-C (TVI output)
Dimensions	Φ 111 mm × 82.4 mm (Φ 4.4" × 3.2")
Weight	Approx.500 g (1.10 lb.)

AC346-OD 2.8mm

5 MP Ultra-Low Light Camera

Dimension

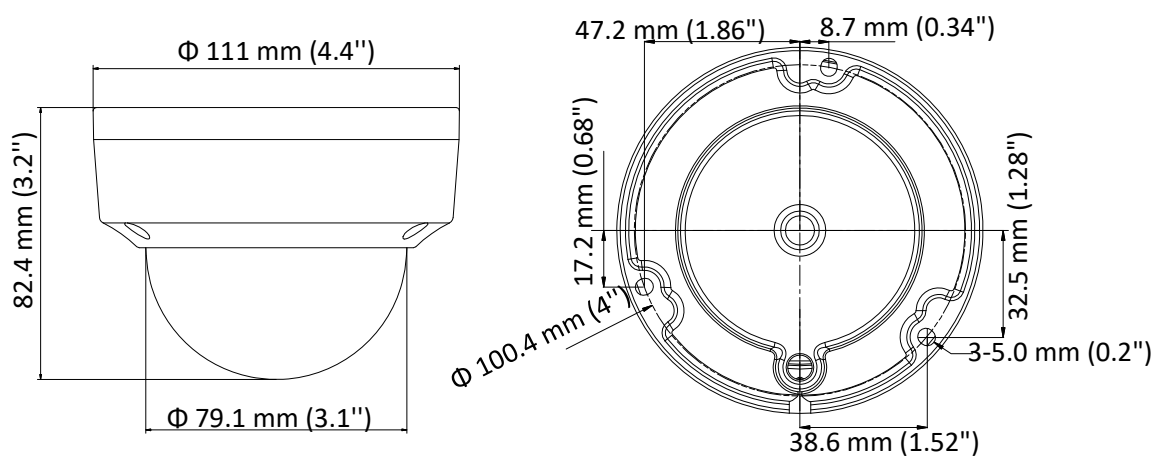

AC346-OD 2.8mm

5 MP Ultra-Low Light Camera

Accessory

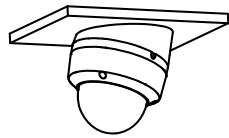

1259ZJ
Inclined Ceiling Mount

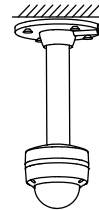

1271ZJ-110
Pendant Mount

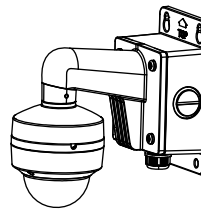

1272ZJ-110B
Wall Mount



1272ZJ-110
Wall Mount

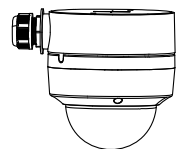

1280ZJ-DM18
Junction Box

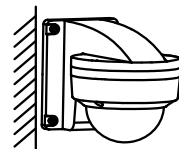

1258ZJ
Wall Mount

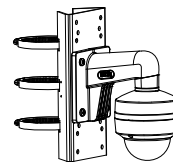

1275ZJ-SUS
Vertical Pole Mount