

AC306-FD4 3.6mm

5 MP Ultra-Low Light EXIR Turret Camera



Key Features

- 5 megapixel high-performance CMOS
- HD analog output, up to 5 MP resolution
- 3.6mm fixed focal lens
- True Day/Night
- OSD menu, DNR, Smart IR
- EXIR technology, up to 40 m IR distance
- IP67
- Up the Coax (HIKVISION-C)



AC306-FD4 3.6mm

5 MP Ultra-Low Light EXIR Turret Camera

Specification

Camera	
Image Sensor	5 MP CMOS image sensor
Resolution	2560 (H) × 1944 (V)
Min. illumination	Color: 0.008 Lux @ (F1.2, AGC ON), 0 Lux with IR
Shutter Time	PAL: 1/25 s to 1/50, 000 s NTSC: 1/30 s to 1/50, 000 s
Lens	3.6 mm fixed focal lens
Horizontal Field of View	70° (3.6 mm)
Lens Mount	M12
Day & Night	ICR
Angle Adjustment	Pan: 0° to 360°; Tilt: 0° to 75°; Rotate: 0° to 360°
Synchronization	Internal synchronization
Frame Rate	2560 × 1944 @ 20fps
Menu	
AGC	Support
D/N Mode	Auto/Color/BW (Black and White)
White Balance	ATW/MWB
BLC	Support
DWDR (Digital Wide Dynamic Range)	Support
Language	English, Chinese
Functions	Brightness, Sharpness, Digital noise reduction, Mirror, Smart IR
Interface	
Video Output	1 HD analog output
General	
Operating Conditions	-40 °C to 60 °C (-40 °F to 140 °F), humidity: 90% or less (non-condensation)
Power Supply	12 V DC ±25%
Power Consumption	Max. 3.5 W
Protection Level	IP67
Material	Metal & plastic
IR Range	Up to 40 m
Communication	Up the coax, Protocol: HIKVISION-C (TVI output)
Dimensions	Φ 110 mm × 93.2 mm (Φ 4.33" × 3.67")
Weight	350 g (0.77 lb.)

AC306-FD4 3.6mm

5 MP Ultra-Low Light EXIR Turret Camera

Dimension

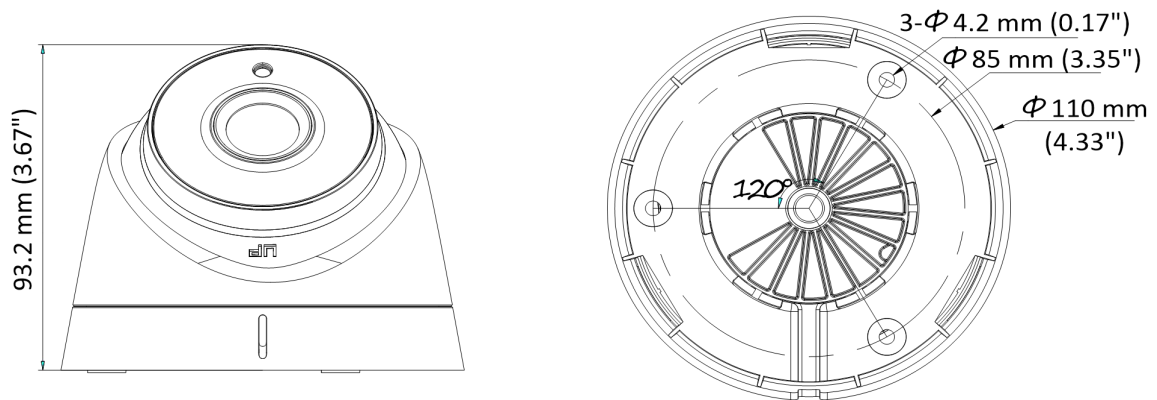

Accessory



1273ZJ-130-TRL
Wall Mount



1275ZJ
Vertical Pole Mount



1276ZJ
Corner Mount



1280ZJ-DM8
Junction Box



1281ZJ-M
Inclined Ceiling Mount