

IPC-PD42212-C

2Mp Full HD 12x Mini Network PTZ Dome Camera



Features

- Powerful 12x optical zoom
- H.264 & MJPEG dual-stream encoding
- Max. 25/30fps@1080P(1920×1080) & 50/60fps@720P resolution
- DWDR, Day/Night (ICR), DNR (2D&3D), Auto iris, Auto focus, AWB, AGC, BLC
- Max 300°/s pan speed, 360° continuous pan rotation
- Up to 80 presets, 5 auto scan, 8 tour, 5 pattern
- Built-in 2/1 alarm in/out
- Support intelligent 3D positioning with DH-SD protocol
- IP66, POE+



IPC-PD42212-C

Technical Specifications:

Model	IPC-PD42212-C		
Camera			
Image Sensor	1/2.8" Exmor CMOS		
Effective Pixels	1944(H) x 1092(V), 2 Megapixels		
Horizontal Resolution	>1000TVL		
Scanning System	Progressive		
Electronic Shutter Speed	1/3s ~1/30,000s		
Min. Illumination	Color: 0.05 Lux/F1.6, B/W: 0.005Lux/F1.6		
S/N Ratio	More than 55dB		
Camera Features			
Day/Night	Auto(ICR) / Color / B/W		
Backlight Compensation	BLC / HLC / DWDR (Digital WDR)		
White Balance	Auto, ATW, Indoor, Outdoor, Manual		
Gain Control	Auto / Manual		
Noise Reduction	2D / 3D		
Privacy Masking	Up to 24 areas		
Digital Zoom	16x		
Lens			
Focal Length	5.1 mm~61.2mm (12x Optical zoom)		
Max Aperture	F1.6~ F3.0		
Focus Control	Auto / Manual		
Angle of View	H: 51.3° ~ 4.64°		
Close Focus Distance	100mm~1000mm		
PTZ			
Pan/Tilt Range	Pan: 0° ~ 360° endless; Tilt: -2° ~ 90°, auto flip 180°		
Manual Control Speed	Pan: 0.1° ~ 300°/s; Tilt: 0.1° ~ 120°/s		
Preset Speed	Pan: 300°/s; Tilt:200°/s		
Preset	80(DH-SD)		
PTZ Mode	5 Pattern, 8 Tour, 5 Auto Scan, Auto Pan		
Speed Setup	Human-oriented focal length/ speed adaptation		
Power up Action	Auto restore to previous PTZ and lens status after power failure		
Idle Motion	Activate Preset/Pan/Scan/Tour/Pattern if there is no command in the specified period		
Video			
Compression	H.264 / MJPEG		
Resolution	1080P(1920×1080)/720P(1280×720)/D1(704×576/704×480)/CIF(352×288/352×240)		
Frame Rate	Main Stream	1080P/ D1 (1 ~ 25/30fps), 720P(1~50/60fps)	
	Sub Stream	D1/CIF(1 ~ 25/30fps)	
Bit Rate	H.264: 448K ~ 8192Kbps, MJPEG: 56K ~ 20480Kbps		



IPC-PD42212-C

Audio			
Compression	G.711a / G.711u (32kbps) / PCM (128kbps)		
Interface	1/1 channel In/Out		
Network			
Ethernet	RJ-45 (10/100Base-T)		
Protocol	IPv4/IPv6, HTTP, HTTPS, SSL, TCP/IP, UDP, UPnP, ICMP, IGMP, SNMP, RTSP, RTP, SMTP, NTP, DHCP, DNS, PPPOE, DDNS, FTP, IP Filter, QoS, Bonjour		
Compatibility	ONVIF PSIA CGI		
Max. User Access	20 users		
Smart Phone	iPhone, iPad, Android, Windows Phone		
Auxiliary Interface			
Memory Slot	Micro SD, Max 64GB		
RS485	N/A		
Alarm	2/1 channel In/Out		
General			
Power Supply	AC24V/1.5A (±10%), POE plus (802.3at)		
Power Consumption	12W, 22W(Heater on)	12W	
Working Environment	-20°C ~ 60°C / Less than 90% RH		
Ingress Protection	IP66	N/A	
Vandal Resistance	IK10		
Dimensions	Φ198mm×158mm		
Weight	2.3Kg		

IPC-PD42212-C

Dimensions (mm)

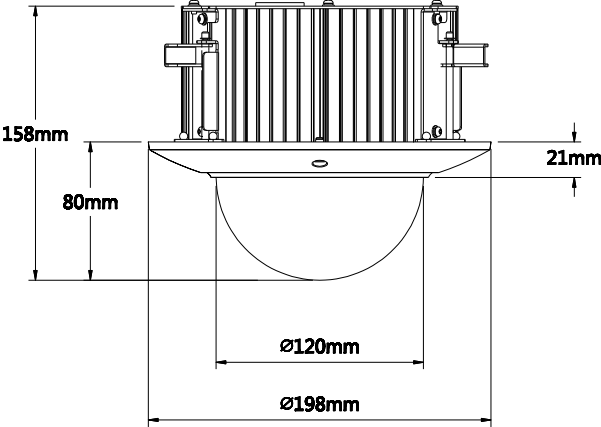









IPC-PD42212-C

IPC-PD42212-C

Accessories (Optional)

W-IPSD42C212S

				
PFA102	PFB300S	PFB302S	PFB300C	PFA113

			
PFA112	PFA120	PFA150	PFA151

Winic Technologies USA Inc.

42 Central Avenue, Farmingdale, New York

11735 Tel: +631-396-0800

Fax: +631-396-0805

Email:sales@winictech.com

www.winictech.com

*Design and specifications are subject to change without notice.

